



FCB-EV7520



FCB-EV7320



FCB-EV7500



FCB-EV7100



FCB-EV7300



FCB-EV5500



FCB-EV7310



FCB-EV5300



FCB-EV Series

Colour Block Cameras

Exmor 

STARVIS

FCB-EV7520
FCB-EV7320

Exmor™

FCB-EV7500
FCB-EV7300
FCB-EV7310
FCB-EV7100
FCB-EV5500
FCB-EV5300

FCB-EV7520
FCB-EV7320

FCB-EV7500
FCB-EV7300
FCB-EV7310
FCB-EV7100
FCB-EV5500
FCB-EV5300



Sony expands the FCB-EV Series camera block line-up with the introduction of two new high-sensitivity, high-quality cameras. The new FCB-EV7520 and FCB-EV7320 incorporate a 1/2.8-type Exmor R™ CMOS sensor which provides Full-HD video with extraordinary sensitivity.

In addition, these cameras incorporate STARVIS™ technology to realize high picture quality in visible light and near-infrared light.

Now Sony's FCB-EV Series offers a broad range of products from 10x to 30x optical zoom, and either HD or Full-HD. All of these cameras inherit a multitude of Sony's world-renowned FCB features, including Auto ICR, Spherical Privacy Zone Masking, and Defog.

Features

	FCB-EV7500	FCB-EV7520	FCB-EV7300	FCB-EV7320	FCB-EV7310	FCB-EV7100	FCB-EV5500	FCB-EV5300
Imager sensor	1/2.8-type Exmor CMOS	1/2.8-type Exmor R CMOS	1/2.8-type Exmor CMOS	1/2.8-type Exmor R CMOS	1/2.8-type Exmor CMOS		1/3-type Exmor CMOS	
Lens	30x		20x			10x	30x	20x
Picture quality	Full HD 1080p (1920 x 1080)						HD (1280 x 720)	
Minimum illumination*	Colour: 0.35 lx (F1.6, AGC on, 1/30 s)	Colour: 0.01 lx (F1.6, AGC on, 1/30 s)	Colour: 0.1 lx (F1.6, AGC on, 1/30 s)	Colour: 0.01 lx (F1.6, AGC on, 1/30 s)	Colour: 0.1 lx (F1.6, AGC on, 1/30 s)	Colour: 0.35 lx (F1.8, AGC on, 1/30 s)	Colour: 0.25 lx (F1.6, AGC on, 1/30 s)	Colour: 0.05 lx (F1.6, AGC on, 1/30 s)
Digital zoom	12x (360x with optical zoom)		12x (240x with optical zoom)			12x (120x with optical zoom)	12x (360x with optical zoom)	12x (240x with optical zoom)
Video output (HD)	Digital/Analog	Digital	Digital/Analog	Digital	Digital	Digital/Analog		Digital
Video output (SD)	VBS							
Mass	260 g (9.2 oz)	255 g (9.0 oz)	270 g (9.6 oz)	265 g (9.3 oz)	270 g (9.6 oz)	210 g (7.4 oz)	260 g (9.2 oz)	270 g (9.6 oz)
Dimensions	50 x 60 x 89.7 mm (2 x 2 3/8 x 3 5/8 inches)		50 x 60 x 87.9 mm (2 x 2 3/8 x 3 1/2 inches)			45.6 x 48.8 x 78 mm (1 13/16 x 1 15/16 x 3 1/8 inches)	50 x 60 x 89.7 mm (2 x 2 3/8 x 3 5/8 inches)	50 x 60 x 87.9 mm (2 x 2 3/8 x 3 1/2 inches)
Defog	●	●	●	●	●	●	●	●
HLC (High Light Compensation)	●	●	●	●	●	●	●	●
Wide-D (Wide Dynamic range)	●	●	●	●	●	●	●	●
Image stabilizer	●	●	●	●	●	●	●	●
StableZoom	●	●	●	●	●	●	●	●
Auto ICR (Auto IR-cut Filter Removal)	●	●	●	●	●	●	●	●
Spherical privacy zone masking	●	●	●	●	●	●	●	●
Noise reduction	●	●	●	●	●	●	●	●
Slow AE response	●	●	●	●	●	●	●	●

* High sensitivity mode, ICR off.

Exmor R CMOS sensor

FCB-EV7520 / FCB-EV7320



FCB-EV7520, FCB-EV7320



current model

Capture crisp, clear Full-HD (1080/60p) images*1

The high-performance 1/2.8-type Exmor CMOS image sensor achieves superb Full-HD (1920 x 1080) picture quality, even in low-light environments. Progressive scanning assures smoother pictures with reduced blur – ideal for capturing the detail in moving images.

Get a steadier picture with image stabilizer*2

The camera's built-in image stabilizer function counters the effect of blurred, shaky images caused by low-frequency vibration. This is useful for outdoor surveillance and traffic monitoring applications, particularly if the camera is used on a bridge or mounting pole where it is subjected to wind or mechanical vibration.

StableZoom

Image stabilizer and optical/digital zoom are combined to enhance picture quality while maintaining the original horizontal angle of view.

This ensures no compromise in image size, and reduces blurring.

2D/3D noise reduction

Advanced noise reduction technology filters noise from the image for clearer results, especially in low-light conditions. Noise reduction can be selected from five levels to suit a wide range of operating environments.

Wide dynamic range

Wide-D image processing technology gives the ability to see clear, detailed images in high-contrast or backlit environments. models now support an exceptionally wide 130 dB dynamic range, which is activated via VISCA command.*3

De-fog

The de-fog feature allows clearer and natural viewing in foggy or misty scenes. When this feature is activated, the camera detects the haze level and automatically applies the required effects. Depending on user requirements, the level of these effects can be adjusted via VISCA command.

HLC (High Light Compensation)

HLC technology helps to improve, for example, the visibility of license plates when bright headlights are shot under low-light conditions. The bright parts in the image are masked and compensated for automatically to achieve better visibility.

Auto ICR (Auto IR-cut Filter Removal)

In low-light conditions, the camera automatically switches from Day to Night mode, removing the IR-cut filter to boost sensitivity for clear pictures in near-darkness. The spherical privacy zone masking feature enables areas of view to be selectively masked for privacy. Masked areas are automatically interlocked with the camera's pan/tilt/zoom movements.

Near-infrared Response

FCB-EV7520 / FCB-EV7320 / FCB-EV7310

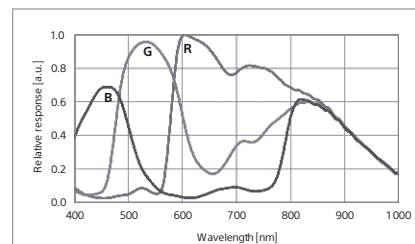

Excludes lens characteristics and light source characteristics

Privacy Zone Masking

Privacy Zone Masking protects private objects and areas such as house windows, entrances, and exits which are within the camera's range of vision but not subject to surveillance. Privacy zones can be masked on the monitor to protect privacy.

Choice of HD and SD output modes

Video signal outputs are available in a range of HD (digital and analog) and SD formats, reducing integration cost and complexity by avoiding the need for additional analog/digital converters. Video output modes can be changed 'on the fly' during normal operation, without a hardware reboot of the camera.

Wide range of features for versatile operation

Versatile operation is ensured by a wide range of functions and adjustments, including: White Balance modes; Picture effects (E-Flip, Nega Art, Black & White, Mirror Image, Colour Enhancement); Motion Detection/Alarm; Picture freeze; Temperature readout; Slow AE response; Electronic shutter/ slow shutter; and Title display/Camera mode display (English).

*1 The FCB-EV5500 and FCB-EV5300 achieve crisp HD 720 picture quality.

*2 Excludes the FCB-EV7310 and FCB-EV7100.

*3 For the FCB-EV7100/FCB-EV7500, the factory default setting is 90 dB. For the FCB-EV7300/FCB-EV5500/FCB-EV5300, it is 130 dB.

FCB-EV Series Specifications

		FCB-EV7500	FCB-EV7520	FCB-EV7300	FCB-EV7320	FCB-EV7310	FCB-EV7100	FCB-EV5500	FCB-EV5300
Image sensor		1/2.8-type Exmor CMOS	1/2.8-type Exmor R CMOS	1/2.8-type Exmor CMOS	1/2.8-type Exmor R CMOS	1/2.8-type Exmor CMOS		1/3.0-type Exmor CMOS	
Image sensor (Number of effective pixels)		Approx.2.38 Megapixels	Approx.2.13 Megapixels	Approx.2.38 Megapixels	Approx.2.13 Megapixels	Approx.2.38 Megapixels		Approx. 1.37 Megapixels	
Signal system		1080p/59.94, 1080p/50, 1080p/60, 1080p/30, 1080p/29.97, 1080p/25, 1080i/59.94, 1080i/50, 1080i/60, 1080i/30, 720p/59.94, 720p/50, 720p/60, 720p/30, 720p/29.97, 720p/25, NTSC ^{*1} , PAL ^{*1}						720p/60, 720p/30, 720p/59.94, 720p/50, 720p/29.97, 720p/25, NTSC ^{*1} , PAL ^{*1}	
Minimum illumination (50%)	High sensitivity mode	Colour: 0.35 lx (F1.6, AGC on, 1/30 s)	Colour: 0.01 lx (F1.6, AGC on, 1/30s)	Colour: 0.1 lx (F1.6, AGC on, 1/30s)	Colour: 0.01 lx (F1.6, AGC on, 1/30s)	Colour: 0.1 lx (F1.6, AGC on, 1/30s)	Colour: 0.35 lx (F1.8, AGC on, 1/30 s)	Colour: 0.25 lx (F1.6, AGC on, 1/30 s)	Colour: 0.05 lx (F1.6, AGC on, 1/30 s)
	Normal mode	Colour: 1.4 lx (F1.6, AGC on, 1/30 s)	Colour: 0.1 lx (F1.6, AGC on, 1/30s)	Colour: 0.4 lx (F1.6, AGC on, 1/30s)	Colour: 0.1 lx (F1.6, AGC on, 1/30s)	Colour: 0.4 lx (F1.6, AGC on, 1/30s)	Colour: 1.4 lx (F1.8, AGC on, 1/30 s)	Colour: 1.0 lx (F1.6, AGC on, 1/30 s)	Colour: 0.2 lx (F1.6, AGC on, 1/30 s)
S/N ratio		More than 50 dB							
Gain	Auto/Manual	0 dB to 43.1 dB (0 to 28 steps +2 step/total 15 steps)	0 dB to 50.0dB (0 to 28 steps +2 step/total 15 steps)	0 dB to 48.8 dB (0 to 28 steps +2 step/total 15 steps)	0 dB to 50.5dB (0 to 28 steps +2 step/total 15 steps)	0 dB to 47.8 dB (0 to 28 steps +2 step/total 15 steps)	0 to 43.5 dB (0 to 28 steps +2 step/total 15 steps)	0 dB to 47.0 dB (0 to 28 steps +2 step/total 15 steps)	0 dB to 51.9 dB (0 to 28 steps +2 step/total 15 steps)
	Max. Gain Limit	9.2 to 43.1 dB (6 to 28 steps +2 step/total 12 steps)	10.7 dB to 50.0 dB (6 to 28 steps +2 step/total 12 steps)	17.4 dB to 48.8 dB (6 to 28 steps +2 steps/total 12 steps)	10.8 dB to 50.5 dB (6 to 28 steps +2 steps/total 12 steps)	17.1 dB to 47.8 dB (6 to 28 steps +2 steps/total 12 steps)	9.3 to 43.5 dB (6 to 28 steps +2 step/total 12 steps)	10.1 to 47.0 dB (6 to 28 steps +2step/total 12 steps)	18.5 dB to 51.9 dB (6 to 28 steps +2 step/total 12 steps)
Shutter speed		1/1 s to 1/10,000 s, 22 steps							
Sync system		Internal							
Exposure control		Auto, Manual, Priority mode (shutter priority & iris priority), Bright, EV compensation, Slow AE							
Backlight compensation		Yes							
Aperture control		16 steps							
White balance		Auto, ATW, Indoor, Outdoor, Outdoor Auto, Sodium Vapor Lamp (Fix/Auto/Outdoor Auto), One-push, Manual							
Lens		30x optical zoom f = 4.3 mm (wide) to 129.0 mm (tele) F1.6 to F4.7		20x optical zoom f = 4.7 mm (wide) to 94.0 mm (tele) F1.6 to F3.5		10x optical zoom f = 3.8 mm (wide) to 38 mm (tele) F1.8 to F3.4	30x optical zoom f = 4.3 mm (wide) to 129.0 mm (tele) F1.6 to F4.7	20x optical zoom f = 4.7 mm (wide) to 94.0 mm (tele) F1.6 to F3.5	
Digital zoom		12x (360x with optical zoom)		12x (240x with optical zoom)		12x (120x with optical zoom)	12x (360x with optical zoom)	12x (240x with optical zoom)	
Focusing system		Auto (Sensitivity: normal, low), One-push AF, Manual, Interval AF, Zoom Trigger AF, Focus compensation in ICR on							
Horizontal viewing angle	1080p mode	63.7° (wide end) to 2.3° (tele end)		59.5° (wide end) to 3.3° (tele end)		67.0° (wide end) to 7.6° (tele end)	-		
	720p mode	63.7° (wide end) to 2.3° (tele end)		59.5° (wide end) to 3.3° (tele end)		67.0° (wide end) to 7.6° (tele end)	58.3° (wide end) to 2.1° (tele end)	54.1° (wide end) to 2.9° (tele end)	
	SD	47.8° (wide end) to 1.7° (tele end)		44.6° (wide end) to 2.5° (tele end)		50.3° (wide end) to 5.7° (tele end)	58.3° (wide end) to 2.1° (tele end)	54.1° (wide end) to 2.9° (tele end)	
Minimum object distance		10 mm (wide end) to 1200 mm (tele end) (Default: 300 mm)		10 mm (wide end) to 1,000 mm (tele end) (Default: 300 mm)		10 mm (wide end) to 800 mm (tele end) (Default: 320 mm)	10 mm (wide end) to 1200 mm (tele end) (Default: 300 mm)	10 mm (wide end) to 1,000 mm (tele end) (Default: 300 mm)	
Auto ICR		Yes							
Wide-D ^{*2}		Yes (130 dB)	Yes (120 dB)	Yes (130 dB)	Yes (120 dB)	No	Yes (130 dB)		
Visibility Enhancer		Yes							
De-fog		Yes							
HLC		Yes							
Noise reduction		Yes (6 steps)							
Image stabilization		Yes				No	Yes		
StableZoom		Yes							
Spherical privacy zone masking		Yes							
Motion detection		Yes							
Alarm		Yes							
Slow AE response		Yes							
Picture effects		E-Flip, Nega Art, Black & White, Mirror image, Colour enhancement							
Picture freeze		Yes							
Slow shutter		Yes							
Temperature readout		Yes							
Title display		20 characters/line, max. 11 lines							
Camera mode display		Yes							
Key switch control		No							
Camera operation switch		No							
Video output	HD	Analog: Component (Y/Ps/Pr)	N/A	Analog: Component (Y/Ps/Pr)	N/A	Analog: Component (Y/Ps/Pr)		N/A	
	SD	Digital: Y/Cs/Cr 4:2:2 via LVDS (Signal format conforms to SMPTE 274/SMPTE 296.)						Digital: Y/Cs/Cr 4:2:2 via LVDS (Signal format conforms to SMPTE 296.)	
Camera control interface		VBS							
Power requirements		VISCA (CMOS 5 V level)							
Power consumption		Baud rate: 9.6 Kbps, 19.2 Kbps, 38.4 Kbps, 115.2 Kbps, Stop bit: 1 bit							
Operating temperature		6.0 V to 12.0 V DC							
Storage temperature		2.9 W (zoom/focus inactive)	3.2 W (zoom/focus inactive)	3.0 W (zoom/focus inactive)	3.2 W (zoom/focus inactive)	2.4 W (zoom/focus inactive)	3.4 W (zoom/focus inactive)	2.9 W (zoom/focus inactive)	1.9 W (zoom/focus inactive)
Operating humidity		3.7 W (zoom/focus active)	4.0 W (zoom/focus active)	3.5 W (zoom/focus active)	3.6 W (zoom/focus active)	2.9 W (zoom/focus active)	3.7 W (zoom/focus active)	3.5 W (zoom/focus active)	2.4 W (zoom/focus active)
Storage humidity		-5°C to +60°C (23°F to 140°F)							
Dimensions (W x H x D)		-20°C to +60°C (-4°F to 140 °F)							
Mass		20% to 80%, Absolute humidity: 36 g/m ³							
		20% to 95%, Absolute humidity: 36 g/m ³							
		50.0 x 60.0 x 89.7 mm (2 x 2 3/8 x 3 5/8 inches)		50.0 x 60.0 x 87.9 mm (2 x 2 3/8 x 3 1/2 inches)			45.6 x 48.8 x 78.0 mm (1 13/16 x 1 15/16 x 3 1/8 inches)	50.0 x 60.0 x 89.7 mm (2 x 2 3/8 x 3 5/8 inches)	50.0 x 60.0 x 87.9 mm (2 x 2 3/8 x 3 1/2 inches)
		260 g (9.2 oz)	255 g (9.0 oz)	270 g (9.6 oz)	265 g (9.3 oz)	270 g (9.6 oz)	210 g (7.4 oz)	260 g (9.2 oz)	270 g (9.6 oz)

*1 Non-standard video format *2 Wide dynamic range

FCB-EV7500 / FCB-EV7520 / FCB-EV5500

Front

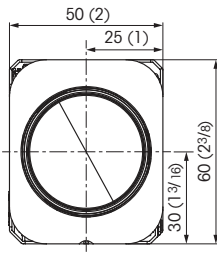

Top

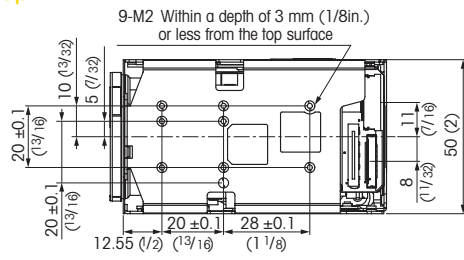

Bottom

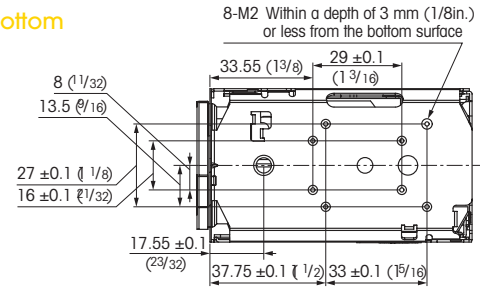

Rear

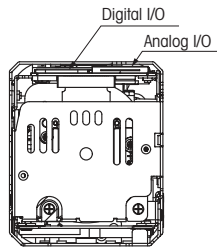

Left

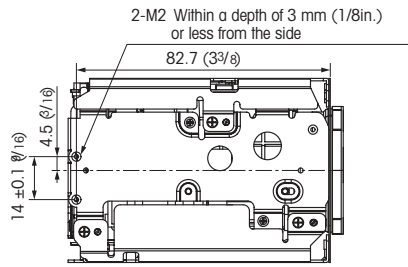

Right

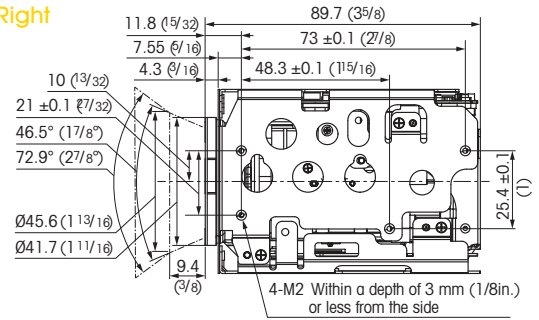

Unit: mm (inches)

FCB-EV7300 / FCB-EV7320 / FCB-EV7310 / FCB-EV5300

Front

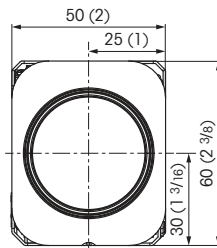

Top

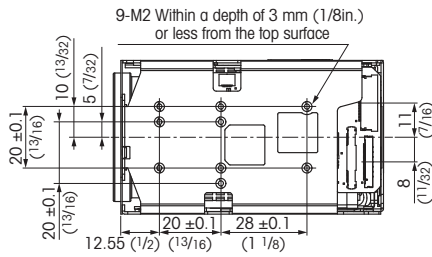

Bottom

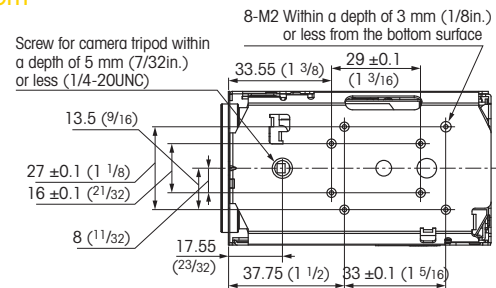

Rear

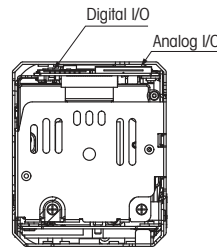

Left

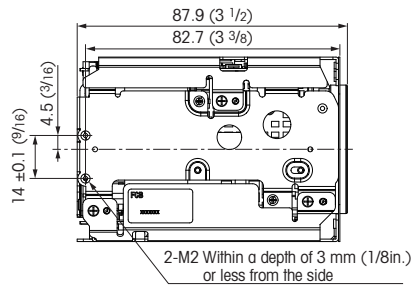

Right

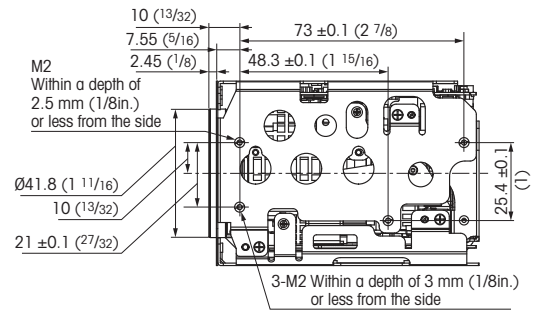

Unit: mm (inches)

FCB-EV7100

Front

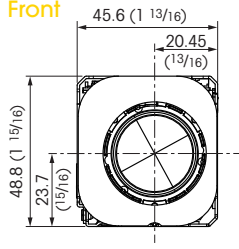

Top

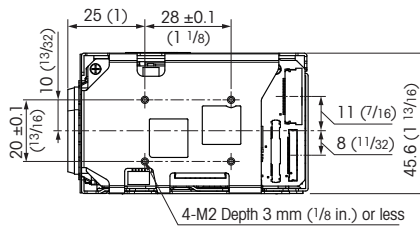

Bottom

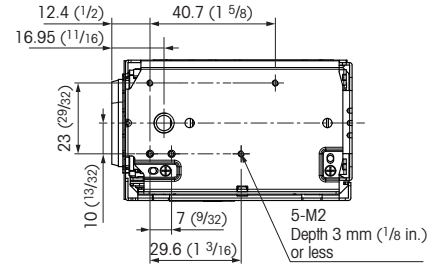

Rear

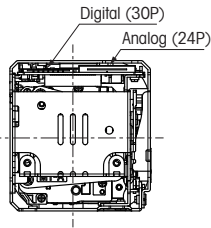

Left

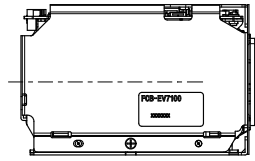

Right

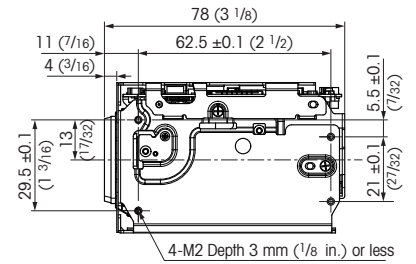

Unit: mm (inches)

Pin assignment & connector

CN401

Pin No.	Name	Level
1	TXOUT3+	
2	TXOUT3-	
3	TXCLKOUT+	
4	TXCLKOUT-	
5	TXOUT2+	
6	TXOUT2-	
7	TXOUT1+	
8	TXOUT1-	
9	TXOUT0+	
10	TXOUT0-	
11	GND	
12	TxD	CMOS 5 V (Low: Max. 0.1 V, High: Min. 4.4 V)
13	RxD	CMOS 5 V (Low: Max. 1.0 V, High: Min. 2.3 V)
14	DC IN	6 to 12 V DC
15	DC IN	6 to 12 V DC
16	DC IN	6 to 12 V DC
17	DC IN	6 to 12 V DC
18	DC IN	6 to 12 V DC

Connector: USL00-30L-C (KEL Co.)

Pin No.	Name	Level
19	GND	
20	GND	
21	TXOUT7+	Single out mode: open
22	TXOUT7-	Single out mode: open
23	TXOUT6+	Single out mode: open
24	TXOUT6-	Single out mode: open
25	NC	
26	RESET	Reset: Low (GND) Normal: Open (1.8 V)
27	TXOUT5+	Single out mode: open
28	TXOUT5-	Single out mode: open
29	TXOUT4+	Single out mode: open
30	TXOUT4-	Single out mode: open

CN501

FCB-EV7520, FCB-EV7320

Pin No.	Name	Level
1	GND	
2	TxD	CMOS 5 V (Low: Max. 0.1 V, High: Min. 4.4 V)
3	RxD	CMOS 5 V (Low: Max. 1.0 V, High: Min. 2.3 V)
4	RESET	Reset: Low (GND) Normal: Open (1.8 V)
5	GND	
6	NC	
7	GND	
8	NC	
9	GND	
10	VBS-OUT	
11	GND	
12	NC	
13	GND	
14	NC	
15	GND	
16	NC	
17	GND	
18	DC IN	6 to 12 V DC
19	DC IN	6 to 12 V DC
20	DC IN	6 to 12 V DC
21	DC IN	6 to 12 V DC
22	GND	
23	DC IN	6 to 12 V DC
24	GND	

Connector: 046240024006800+ (Kyocera-elco)

FCB-EV7500, FCB-EV7300, FCB-EV7310, FCB-EV7100, FCB-EV5500, FCB-EV5300

Pin No.	Name	Level
1	GND	
2	TxD	CMOS 5 V (Low: Max. 0.1 V, High: Min. 4.4 V)
3	RxD	CMOS 5 V (Low: Max. 1.0 V, High: Min. 2.3 V)
4	RESET	Reset: Low (GND) Normal: Open (1.8 V)
5	GND	
6	NC	
7	GND	
8	NC	
9	GND	
10	VBS-OUT	
11	GND	
12	Y-OUT	HD Analog Component
13	GND	
14	Pb-OUT	HD Analog Component
15	GND	
16	Pr-OUT	HD Analog Component
17	GND	
18	DC IN	6 to 12 V DC
19	DC IN	6 to 12 V DC
20	DC IN	6 to 12 V DC
21	DC IN	6 to 12 V DC
22	GND	
23	DC IN	6 to 12 V DC
24	GND	

Distributed by

©2015 Sony Corporation. All rights reserved. Reproduction in whole or in part without written permission is prohibited. Features and specifications are subject to change without notice. The values for mass and dimensions are approximate. "SONY", "Exmor", "Exmor R" and "STARVIS" are registered trademarks of Sony Corporation. All other trademarks are the property of their respective owners.

PHC_25/11/2015